

RUDDERS

ELICHE RADICE S.p.A.

EUROPES LARGEST VOLUME PROPELLER MANUFACTURER

Type 16/17-S.0° Weight 15 Kg

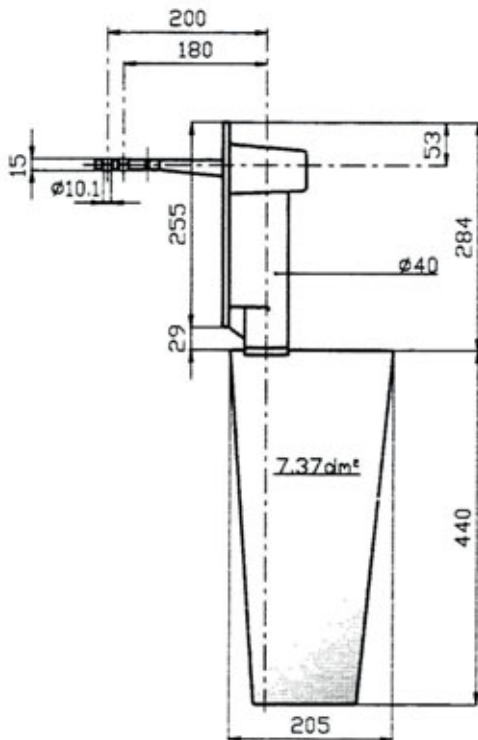

Type 16/17-P Weight 12 Kg

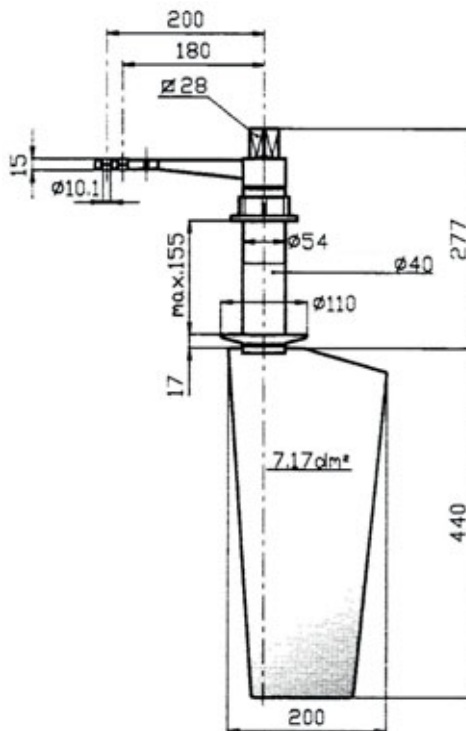

Light Duty	
Series	Price
12 6 V	£430.00
12 6 P	£430.00
16 7 P	£630.00
16 7 V	£630.00
16 7 S 0	£680.00
16 7 S 12	£680.00
14 10 P	£690.00
14 10 V	£690.00
14 10 V 10	£690.00
14 10 S 0	£745.00
14 10 S 12	£745.00
16 11 P	£755.00
16 11 V	£755.00
16 11 S 0	£800.00
16 11 S 12	£800.00
25 11 P&V	£1050.00
16 13 P	£945.00
16 13 V	£945.00
16 13 S 0	£995.00
16 13 S 12	£995.00
45 16 P	£2400.00
45 16 V	£2400.00
45 19 P	£2460.00
45 19 V	£2460.00
4520 P	£2460.00
4520 V	£2460.00
5018 P	£3860.00

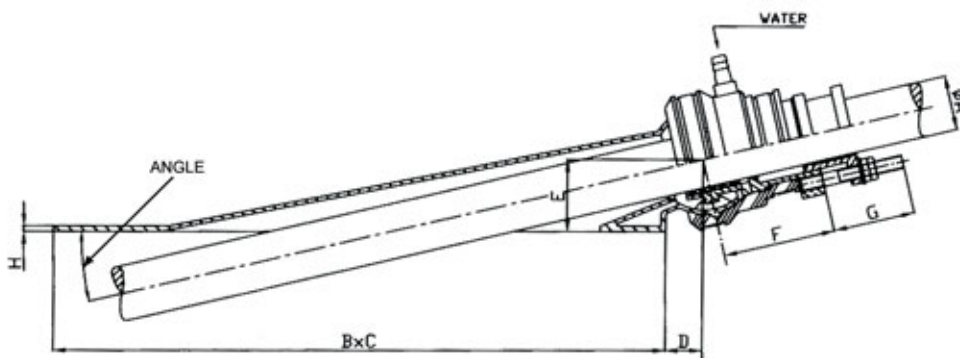

SHAFT LOGS

With flexi inboard gland

A	ANGLE	B	C	D	E	F	G	H	Price	
25 - 30	1" - 1 1/4"	9° - 17°	460	90	20	48	77	45	5	£260.00
35 - 40	1 3/8" - 1 1/2"	11° - 17°	500	110	27	60	86	75	5	£370.00
45 - 50	2"	11° - 15°	555	130	35	66	103	75	5	£420.00
55 - 60		10° - 15°	730	190	57	85	230	70	8	£1890.00